

# Interkom SENA SF4 przewodnik

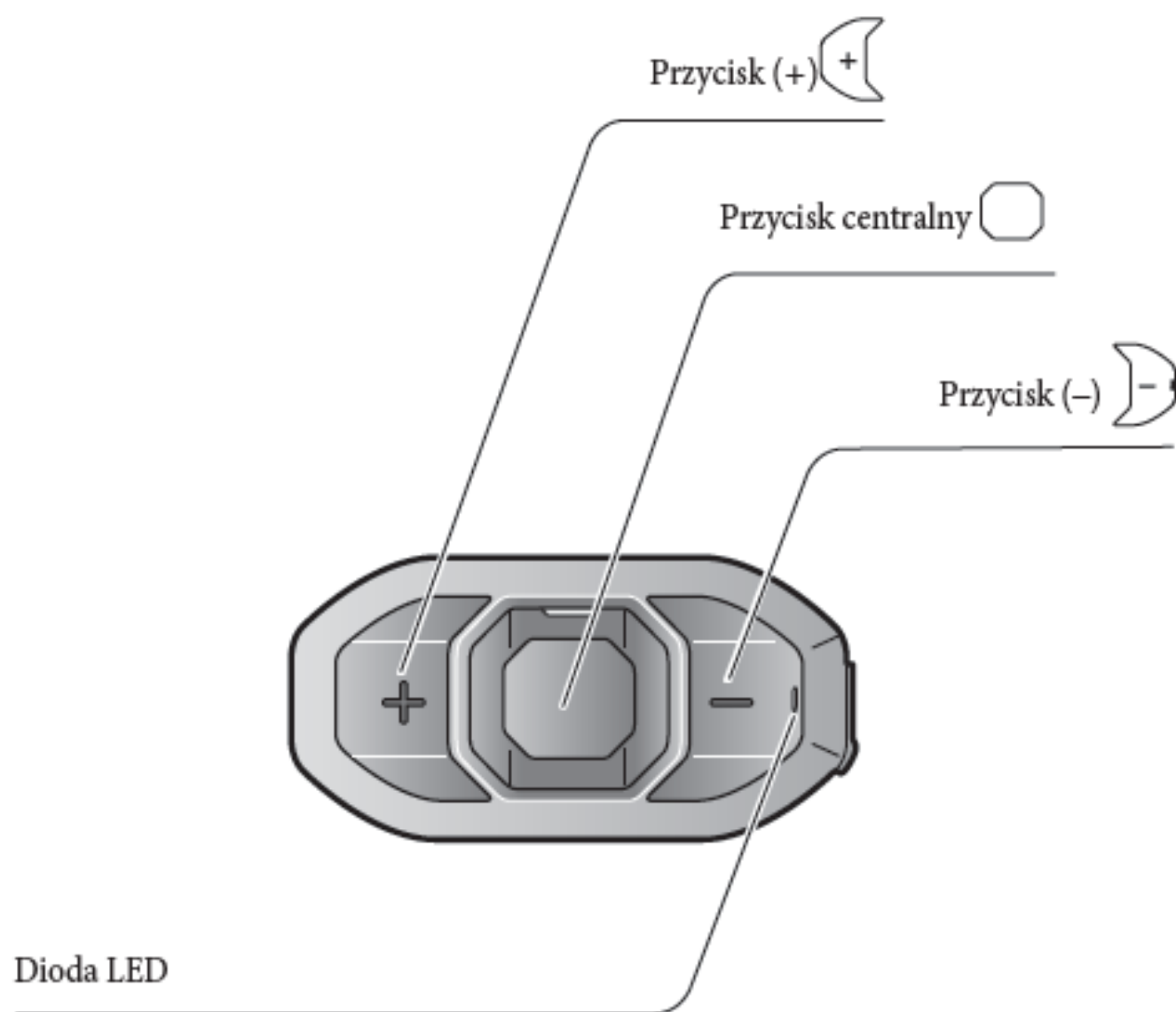

# Instalacja

1

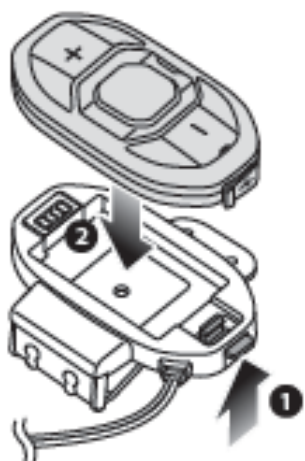

2

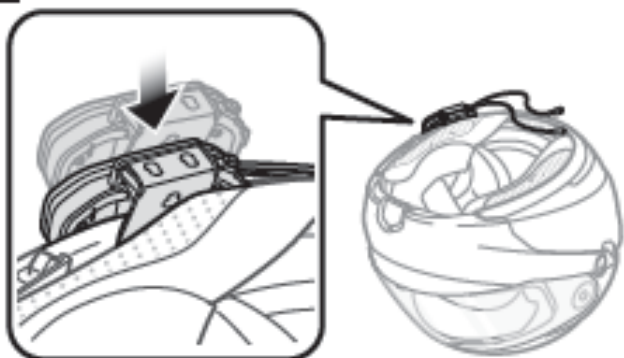

3

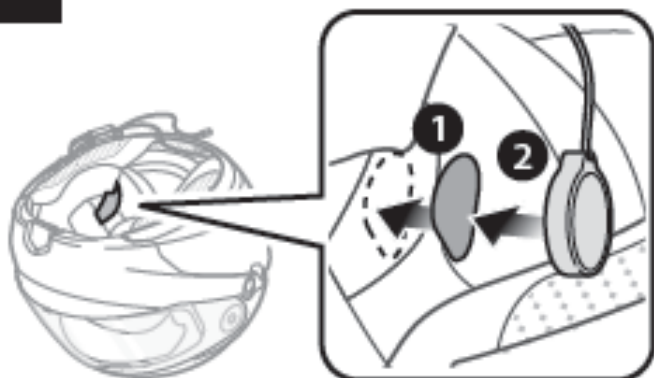

4

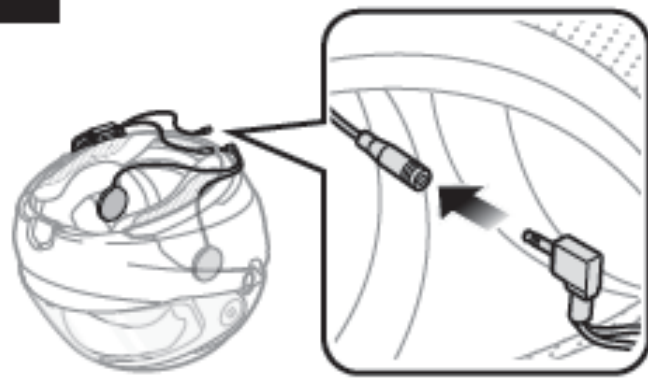

5

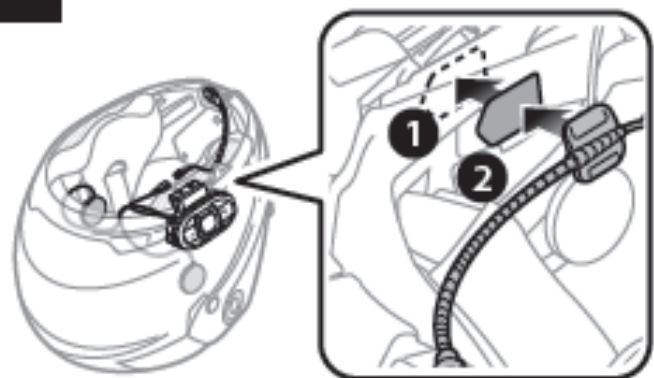

6

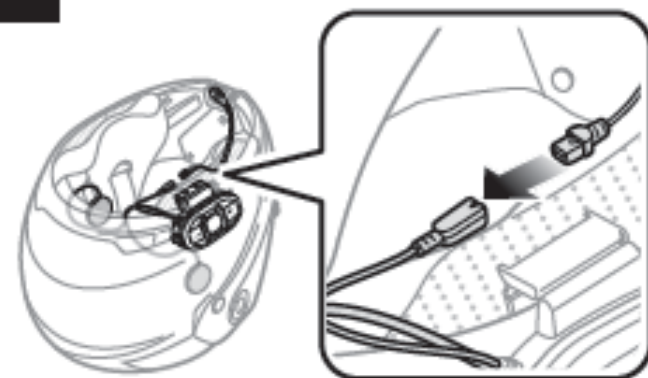

## Ładowanie

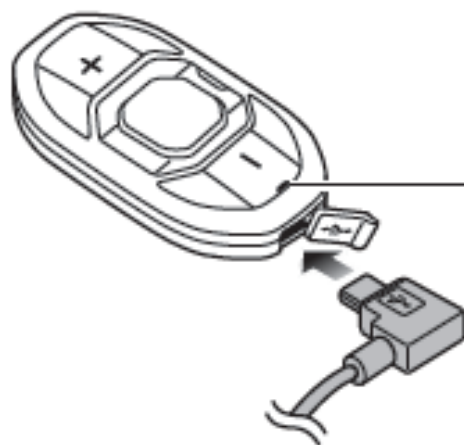

- Czerwona: ładuje
- Niebieska: naładowany

## Operowanie przyciskami

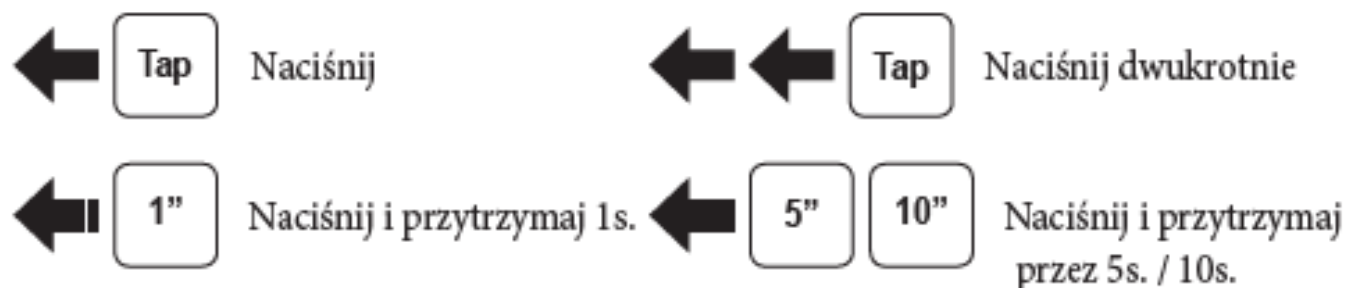

## Włączanie/ wyłączenie



## Regulacja głośności

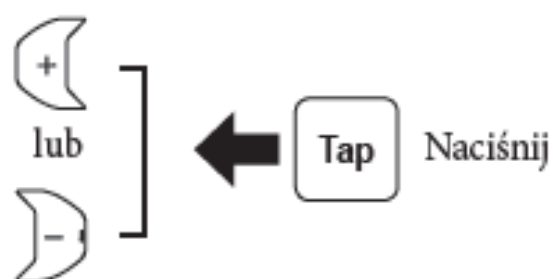

## Sprawdzanie poziomu baterii



Włącz



70 ~ 100%

30 ~ 70%

0 ~ 30%

LED

■ - ■ - ■ ■ ■ ■ - ■ ...

■ - ■ - ■ ■ ■ - ■ ...

■ - ■ - ■ ■ - ■ ...

## Telefon / muzyka Parowanie



10"

Naciskaj przez 10s.



Tap

Naciśnij

Wybierz **Sena SF4**



Wprowadź PIN

0 0 0 0 PIN

LED ■ ■ ■ ■

## Muzyka Operowanie przyciskami



1"

Naciśnij i przytrzymaj 1s.



1"

Naciśnij i przytrzymaj 1s.



1"

Naciśnij i przytrzymaj 1s.



Odbierz



Naciśnij



Zakończ

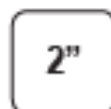

Naciśnij i przytrzymaj przez 2s.



Wybór głosowy

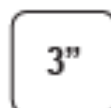

Naciśnij i przytrzymaj przez 3s.



Wybór z listy  
Speed Dial

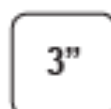

Naciśnij i przytrzymaj przez 3s.



Odrzuć

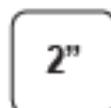

Naciśnij i przytrzymaj przez 2s.

## Interkom Parowanie interkomów

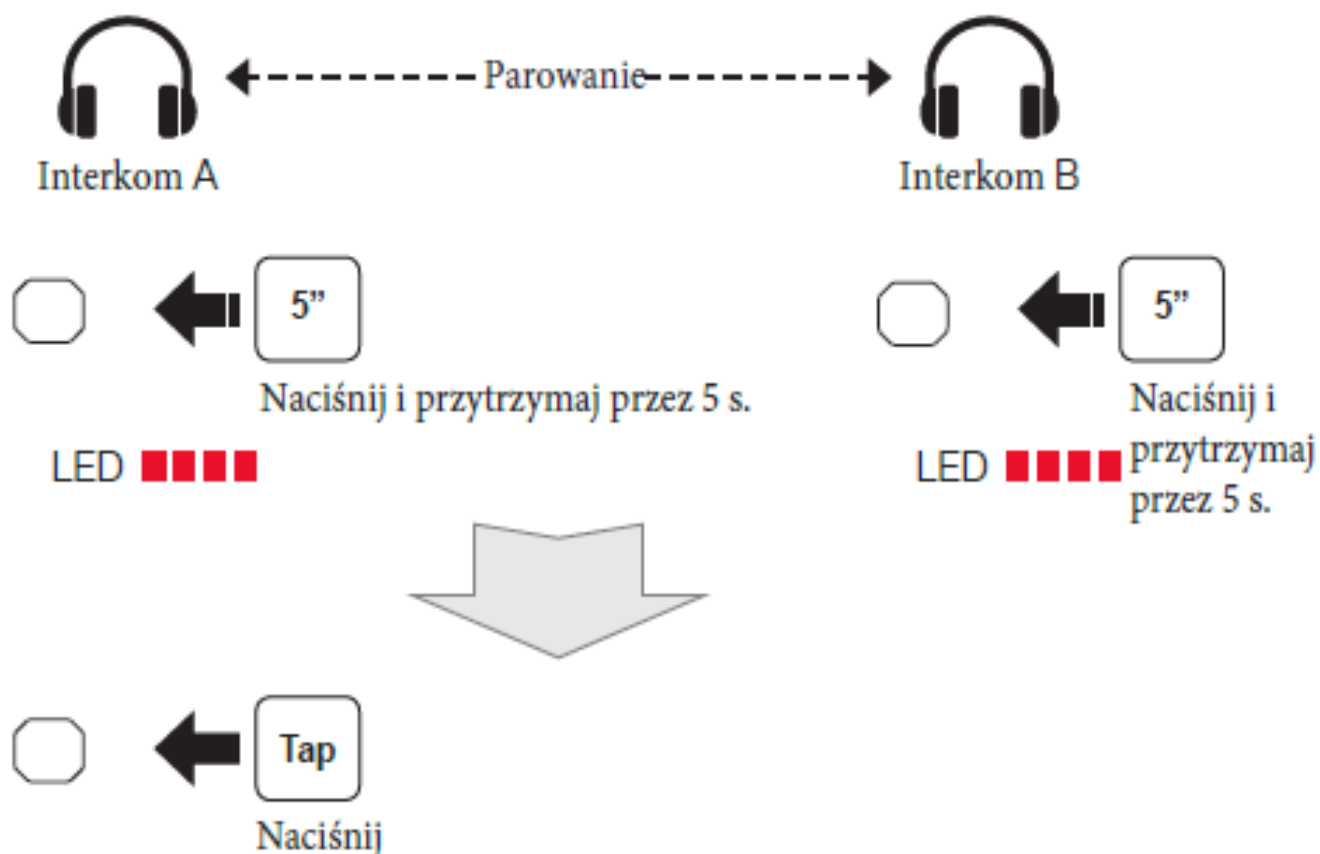

## Interkom Rozpoczynanie i kończenie rozmów



## Radio Wł. i wył.

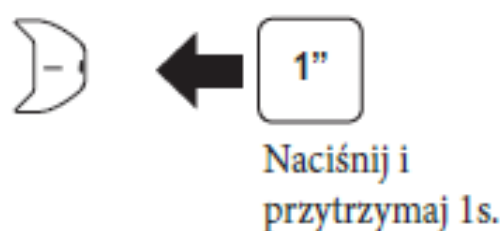

## Radio Wyszukiwanie stacji



## Radio Wyszukiwanie automatyczne stacji



### Zapisywanie wyszukanych stacji



## Radio Przejście do następnej zapisanej stacji

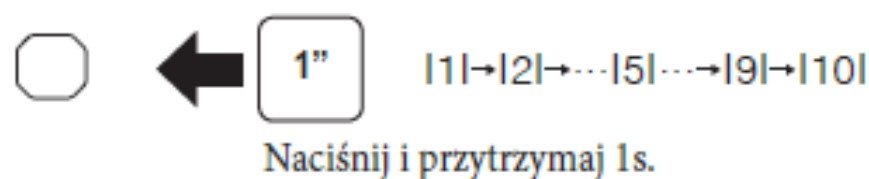

## Radio Zachowywanie lub usuwanie stacji



Naciśnij i przytrzymaj przez 3s.



1 ~ 10, Cancel



lub



Naciśnij



Zapisz



Naciśnij i przytrzymaj przez 1s.

lub



Usuń



Naciśnij i przytrzymaj przez 1s.



## Ustawienia

### Za pomocą menu konfiguracyjnego



Naciśnij i przytrzymaj przez 10s.

### Za pomocą programu Sena Device Manager

Podłącz interkom do komputera za pomocą kabla USB. Uruchom Sena Device Manager i kliknij DEVICE SETTING aby skonfigurować interkom. Więcej szczegółów pobierania i instalowania programu Sena Device Manager znajduje się w ulotce w opakowaniu produktu.

### Za pomocą aplikacji Sena Smartphone App

1. Pobierz na swojego smartphona aplikację **Sena SF Utility App** dla Android czy iPhone z Google Play lub App Store.
2. Sparuj smartphon z interkodem.
3. Uruchom aplikację **Sena SF Utility App**. Przesuń ekran w prawo i wybierz Setting aby skonfigurować ustawienia interkomu.

# Rozwiązywanie problemów

## Przywracanie ustawień fabrycznych

Jeśli chcesz zresetować interkom do ustawień fabrycznych, użyj funkcji Factory Reset w menu konfiguracyjnym. Urządzenie przywróci ustawienia fabryczne i automatycznie się wyłączy.

## Reset

Jeśli urządzenie nie działa właściwie z jakiegokolwiek powodu, naciśnij za pomocą np. spinacza przycisk znajdujący się z tyłu urządzenia.

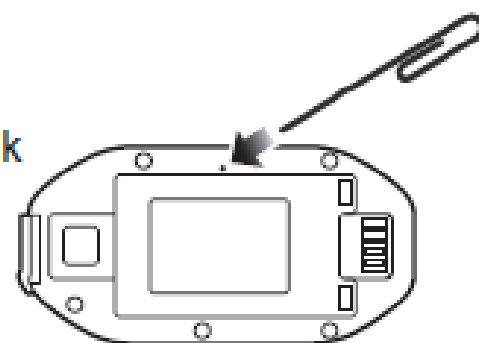

**SENA**



**Sena Technologies, Inc.**

[www.sena.com](http://www.sena.com)

Customer Support: [support.sena.com](http://support.sena.com)

E-mail: [support@sena.com](mailto:support@sena.com)