

**SENA**



# **10C PRO**

**MOTORCYCLE BLUETOOTH® CAMERA  
AND COMMUNICATION SYSTEM**

2.0.0

# RIDE CONNECTED

Rozmawiaj przez interkom ze znajomymi, słuchaj ulubionej muzyki oraz wskazówek z GPS, a także nagrywaj niezapomniane chwile dzięki wbudowanej kamerze Quad HD. Technologia jeszcze nigdy nie była tak wolna i tak dostępna dla wszystkich.



Bluetooth® Integrated



1.6 Km (1.0 Mile) Intercom



Quad HD Camera Integrated



Four-Way Intercom



Unibody Design



Smart Audio Mix™



Advanced Noise Control™



WiFi Enabled



Audio Multitasking™



Audio Source Priority

# INFORMACJE WSTĘPNE

1. Ten przewodnik jest bazową wersją pełnej instrukcji obsługi dostępnej pod adresem [www.sena.com/documents](http://www.sena.com/documents)
2. Możesz za darmo uaktualnić oprogramowanie do najnowszej wersji aby w pełni cieszyć się produktem. Odwiedź stronę [www.sena.com/device-manager-download/](http://www.sena.com/device-manager-download/) i zobacz jak prosto dokonać aktualizacji.
3. Użytkownicy mogą śledzić SENE na portalach Facebook, YouTube, Twitter i Instagram aby otrzymywać najnowsze informacje o produkcie, pomocne wskazówki i wszelkie inne informacje dotyczące produktów SENA.

**SENA**



SENA Technologies, Inc.

[sena.com](http://sena.com)

Customer Support: [support.sena.com](http://support.sena.com)

**10C PRO**

## Jak używać tego przewodnika

Legenda i objaśnienia zostały tak przygotowane, aby pomóc użytkownikowi w czytaniu przewodnika. Stworzyliśmy prosty sposób wykonywania poleceń za pomocą ilustracji.



Funkcje

=



=

Tap = **naciśnij lub Hold = przytrzymaj**

## Przyciski

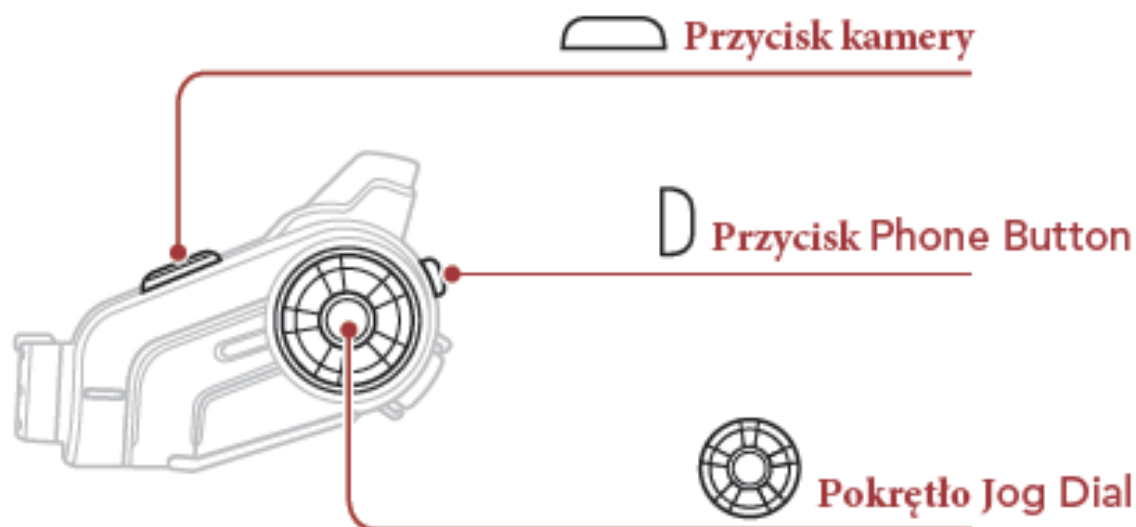

## Ikonki



Naciśnij przycisk określoną ilość razy.



Naciśnij i przytrzymaj przycisk przez określony czas.



Przekręć pokrętle Jog Dial w lewo lub w prawo.



Przekręć pokrętle Jog Dial w lewo lub w prawo jednocześnie go nasickając.



"Hello"

**Słyszalny komunikat z interkomu**

## Ikonki



Naciśnij przycisk określoną ilość razy.



Naciśnij i przytrzymaj przycisk przez określony czas.



Przekręć pokrętle Jog Dial w lewo lub w prawo.



Przekręć pokrętle Jog Dial w lewo lub w prawo jednocześnie go nasickając.



"Hello"

**Słyszalny komunikat z interkomu**

## Instalacja interkomu

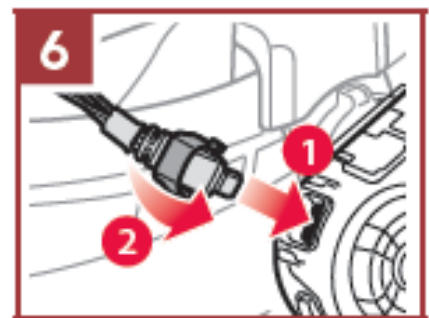
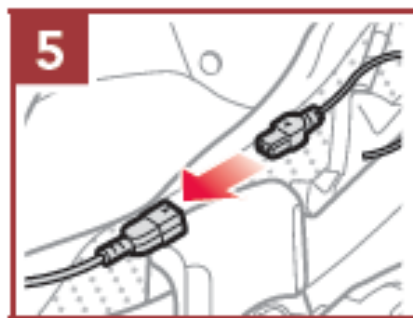
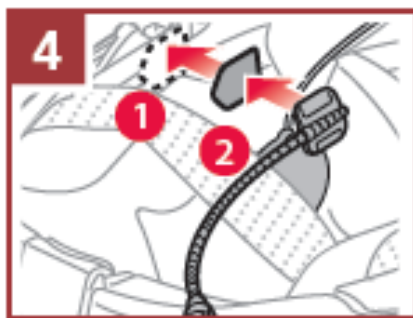
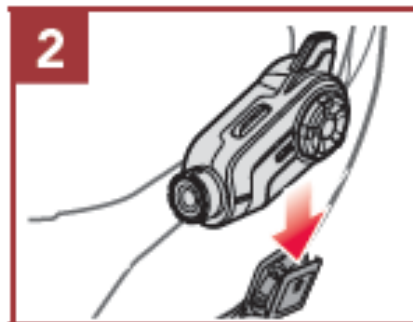
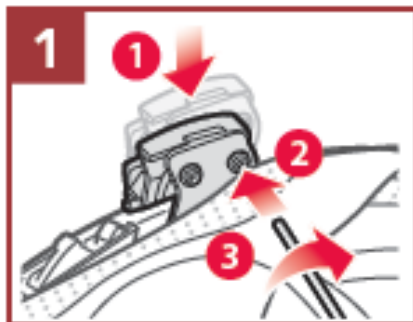

## Operowanie przyciskami

### Włączanie



### Wyłączanie



### Głośność +



### Głośność -

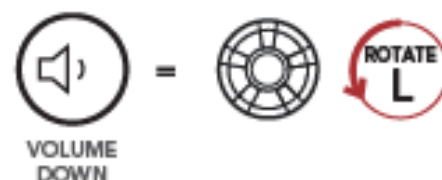

# Sprawdzanie poziomu baterii

## Metoda wizualna

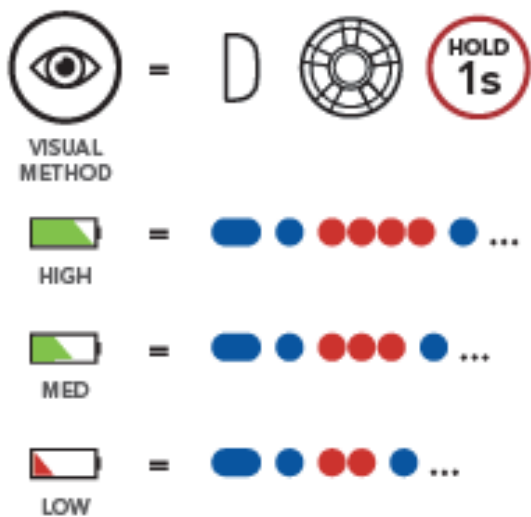

## Metoda dźwiękowa

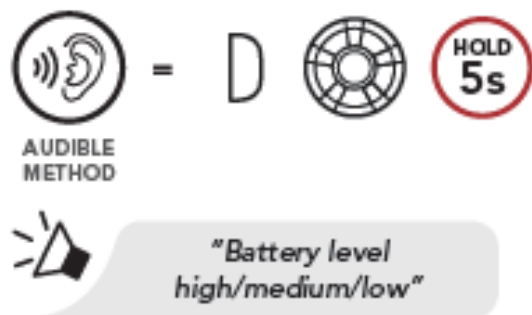

# Parowanie Bluetooth (Telefon, MP3, GPS)

## Parowanie telefonu

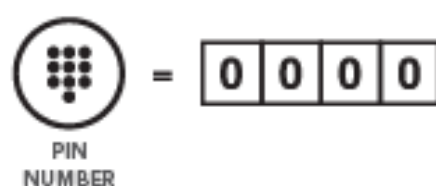
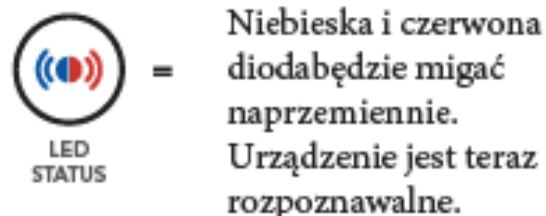



# Telefon

## Odbieranie połączenia



## Odrzucanie połączenia



## Kończenie rozmowy



## Głosowe nawiązanie połączenia

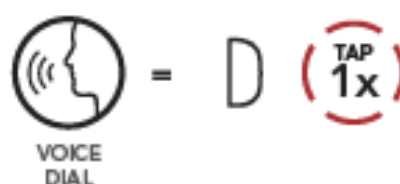

# Słuchanie muzyki

## Start/Pauza



## Wybieranie utworów w przód



## Wybieranie utworów w tył



## Operowanie przyciskami kamery

### Włączanie



"Camera on"

### Nagrywanie video

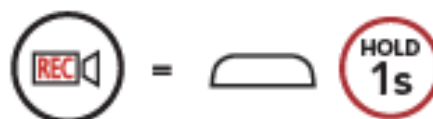

"Recording"

### Wyłączanie



"Camera off"

### Kończenie nagrywania



"Recording stopped"

### Robienie zdjęć



"[Shutter sound]"

### Uwaga:

Nie można nagrywać video bez włożonej karty microSD, która musi być wcześniej sformatowana za pomocą kamery. Kamera obsługuje karty microSD do 64GB oraz klasie 10 lub wyższej.

# Interkom

Możesz sparować do 3 dodatkowych rozmówców w celu utworzenia czteroosobowej konferencji.

## Parowanie interkomów A i B



"Intercom pairing"



YOU

or

=



LED  
STATUS

= Mrugająca niebieska dioda potwierdzi sparowanie interkomów.

## Start/koniec rozmowy z interkmem B



# Wieloosobowa konferencja przez interkom

## Rozpoczynanie



START GROUP  
INTERCOM



"Group intercom"



LED  
STATUS

= Green LED Flashing

## Kończenie



END GROUP  
INTERCOM



"Group intercom  
terminated"

# Radio

## Włączanie radia FM

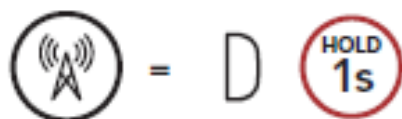

"FM on"

## Wyłączanie radia FM

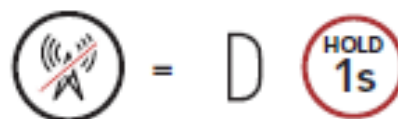

"FM off"

## Wyszukiwanie stacji w przód



SEEK  
FORWARD

## Wyszukiwanie stacji w tył



SEEK  
BACKWARD

# Menu konfiguracyjne

## Dostęp do menu konfiguracyjnego

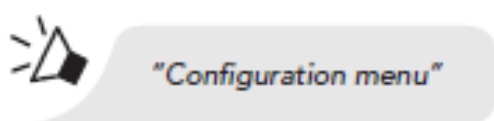
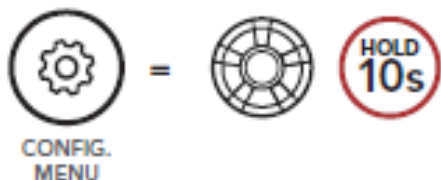

## Włączanie danej funkcji

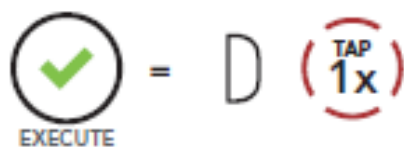

## Nawigowanie pomiędzy funkcjami menu

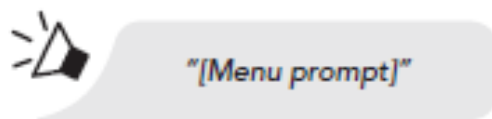
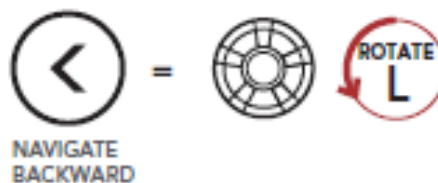
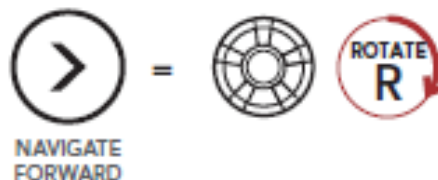

# Menu konfiguracyjne kamery

## Wejście do menu konfiguracyjnego

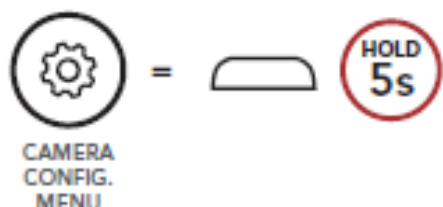

"Camera Setup"

## Włączanie / wyłączanie danej funkcji



ENABLE/  
DISABLE

=



EXECUTE

## Poruszanie się wewnątrz menu



NAVIGATE FORWARD

=



"[Menu prompt]"



NAVIGATE BACKWARD

=



"[Menu prompt]"

# Ustawienia

## Program Sena Device Manager

Sena Device Manager umożliwia aktualizację oprogramowania oraz konfigurację ustawień bezpośrednio z komputera PC. Za pomocą tego oprogramowania można m.in. przypisać numery tel. szybkiego wybierania, ustawić stacje radiowe FM i inne. Aby uzyskać więcej informacji na temat pobierania i instalowania oprogramowania, odwiedź witrynę [Sena.com](http://Sena.com).

## Aplikacja Sena Smartphone App

Aplikacja Sena Smartphone App umożliwia konfigurację ustawień interkomu, a także dostęp do przewodników użytkownika i podręczników szybkiego startu. Aby to zrobić, sparuj telefon komórkowy z interkodem, postępując zgodnie z instrukcjami w rozdziale "Parowanie Bluetooth (telefon, MP3, GPS)" w tym przewodniku. Uruchom aplikację Sena Smartphone App i skonfiguruj ustawienia bezpośrednio ze smartfona. Możesz pobrać aplikację Sena Smartphone App dla systemów Android i Apple z witryny [Sena.com/headset-app](http://Sena.com/headset-app).



Download on the  
**App Store**



GET IT ON  
**Google Play**

## Aplikacja Sena Camera App

Aplikacja Sena Camera App pozwala zobaczyć podgląd na żywo z kamery, zarządzać nagranymi filmami, a także skonfigurować ustawienia wideo za pomocą wbudowanej funkcji WiFi w kamerze. Po połączeniu aparatu z aplikacją Sena Camera App, aplikacja jest synchronizowana z datą i godziną smartfona. Pobierz aplikację Sena Camera App dla systemów operacyjnych Android i Apple ze strony [sena.com](http://sena.com).





# ROZWIĄZYWANIE PROBLEMÓW

## Przywracanie ustawień fabrycznych

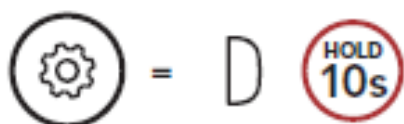

"Factory reset"

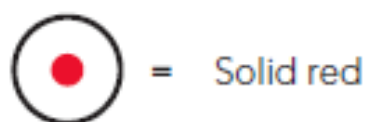

LED  
STATUS























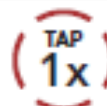





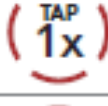

EXECUTE

## Reset

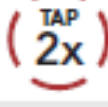

**Uwaga:** Reset nie przywraca interkomu do ustawień fabrycznych

TYP	OPERACJE	OPEROWANIE PRZYCISKAMI
 <b>Basic Operations</b>	Włączanie / wyłączenie	  
		  
	Głośność + / -	  or 
 <b>Mobile Phone</b>	Odbieranie połączenia tel.	 or  
	Kończenie połączenia tel.	  or  
	Odrzucanie połączenia	 
	Przekierowanie połączenia	 
	Głosowe nawiązywanie połączenia	 
	Szybkie wykonywanie połączeń	 

TYP	OPERACJE	OPEROWANIE PRZYCISKAMI
 <b>Music</b>	Włączanie/wyłączanie muzyki	 
	Przełączanie w przód	 
	Przełączanie w tył	 
 <b>Camera</b>	Włączanie kamery	 
	Wyłączanie kamery	  
	Rozpoczęcie / zakończenie nagrywania	 
	Robienie zdjęć	 
 <b>FM Radio</b>	FM radio on/off	 
	Seek forward	 
	Seek backward	 

TYP	OPERACJE	OPEROWANIE PRZYCISKAMI	
 <b>Intercom</b>	Parowanie		
	Start/koniec rozmowy		
	Kończenie wszystkich połączeń		
	Start grupowej konwersacji		
	koniec grupowej konwersacji		